

# VIOMI

Viomi Smart Air Purifier Pro (UV)





## Maintenance Tips

Only maintenance personnel who has been professionally trained and has obtained air purifier maintenance qualification can perform maintenance on the air purifier.

In order to avoid serious consequences, no one else can repair the air purifier without permission.

When your air purifier is abnormal, please refer to "Common Malfunctions Analysis and Exclusion" before contacting the customer service.

If you are unable to troubleshoot, please unplug the power cord and contact us. Any inconvenience caused by product quality or non-product quality factors can be obtained Consulting & Services from the local Viomi Customer Service Center or Foshan Viomi Electrical Technology Co., Ltd. You can call Viomi Customer Service Hotline 400-100-2632 for consultation.

Please read this manual carefully to ensure the correct and safe use of this product.

## Users environmental impacts information

1. All packaging materials are environmentally friendly and recyclable. Please dispose of these packaging materials in an environmentally friendly manner to maintain a good environment.
2. Do not let children play with plastic film and packing boxes, which may cause suffocation accidents, so please keep the packaging materials away from children, the packaging materials are not toys.
3. When the old air purifier cannot be used, it should be discarded. Please dispose of it as something that cannot be reused. The old air purifier contains usefully reusable materials, please assist in proper disposal or recycling to contribute to environmental protection.

## Contents

Products and Accessories	1
Parameters information	1
Using Instructions	2
Electrical Schematics	3
Wi-Fi Connection	3
Filter Replacement	4
Safety Precautions	6
Common Troubleshooting Methods	7

## Warm Tips

Before use, please remove the packaging bag of the filter in the machine. For the removal and installation method of the filter, please refer to "Filter Replacement" on page 4.

## Products and Accessories

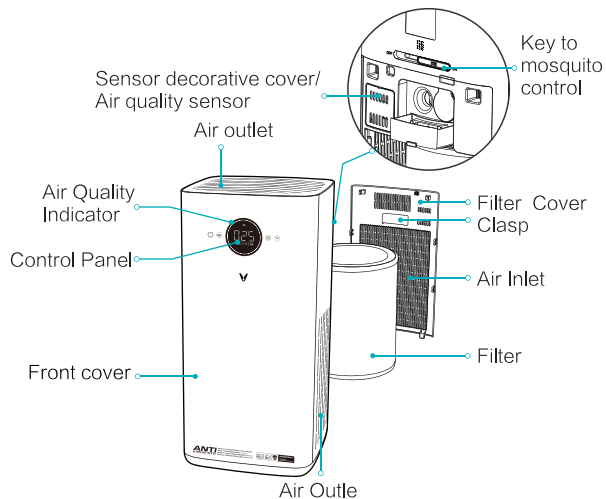

## Parameters Information

Name of Product	Air Purifier
Applicable Model	VXXKJ03
Rated Voltage	220~240V~
Rated Frequency	50/60Hz
Rated Power	45W
CADR(Particles)	500m <sup>3</sup> /h
Cumulate clean mass(CCM Particles)	P4 Level
CADR(Formaldehyde)	200m <sup>3</sup> /h
Applicable Area	35~60m <sup>2</sup>
Size	320 × 320 × 657mm
Net Weight	9.5kg

## Packing List

Name	Whole Machine	Manual	Composite Filter ( Has been equipped into the whole machine )
Quantity	1	1	1

## Using Instruction

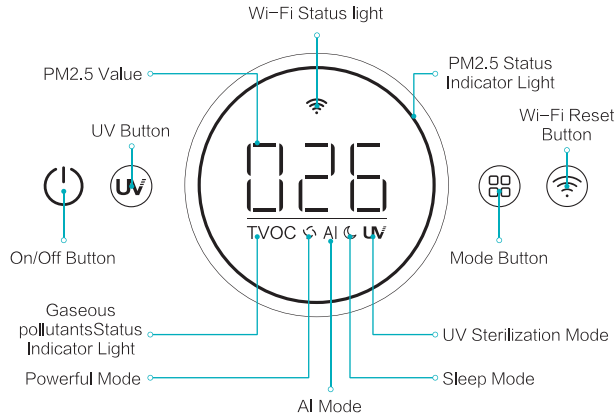

When the machine is powered on, it enters standby mode.

### Power on/ Standby

Short press the key, the screen displays the current PM2.5 value, the system automatically enters the smart mode, short press again, the system enters the standby state, and close all functions.

### UV Sterilization Function

Short press the UV button to turn on the UV sterilization function, and short press again to turn off the UV sterilization function.

### Mode

Short press the mode key to change the current mode. The mode switches cyclically according to "power mode, AI mode, sleep mode".

**Powerful mode:** The system turns on the maximum wind speed to achieve the maximum purification capacity.

**AI mode:** The system automatically adjusts the purification capacity according to the current PM2.5 value and TVOC status.

**Sleep mode:** The system minimizes purification capacity and operates at low wind speeds.

**Screen extinguishing mode:** This mode only supports mobile phone APP operation. After turning on, the system has no operation within 15 seconds and all lights are off. The system turns on the minimum wind speed to reduce the purification capacity.

### Wi-Fi Reset Button

Long press to reset Wi-Fi connection.

### Anion function

The system automatically turns on the negative ion function when it is turned on, and the system automatically turns off this function in standby and sleep modes.

### Air Quality Indicator Function

The PM2.5 status indicator circle on the screen switches between different colors according to the current PM2.5 status.

Orange represents high PM2.5 concentration in the air;

Blue represents medium PM2.5 concentration in the air;

Green indicates low PM2.5 concentration in the air.

The gaseous pollutant status indicator switches between different colors according to the current gaseous pollutant status.

Orange represents heavy gaseous pollution;

Blue represents medium gaseous pollution;

Green represents low gaseous pollution.

### Appointment Function

This function only supports the APP side of the mobile phone, and can be operated on the APP side to reserve the power-on / off time.

### Tips on filter life

**Mobile APP:** When the filter reaches the deadline, it will prompt to replace on the APP. When the filter is replaced, you can press and hold the "UV key + mode key" for 3 seconds to reset the filter life.

**Host:** See the troubleshooting below.

## Anti-mosquito operation method

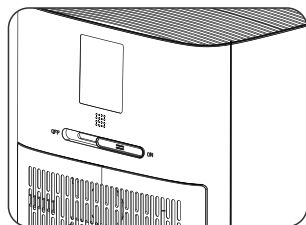

1. In the power-on state, when the mosquito repellent switch is turned ON, the mosquito trap lamp is turned on; when the mosquito repellent switch is turned OFF, the mosquito trap lamp is turned off.

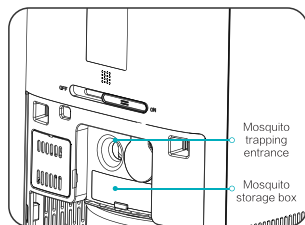

2. Clean up the mosquito storage box  
(1) Before clean the mosquito storage box, push the mosquito repellent switch to OFF, and power off the purifier.

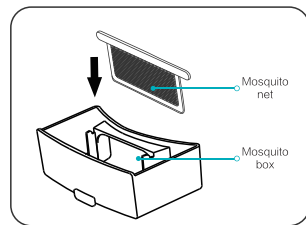

(2) Draw out the mosquito storage box, clean out the debris and mosquito nets in the box. After cleaning, insert the mosquito net into the card slot of the mosquito storage box.

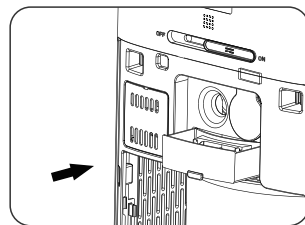

(3) Insert the mosquito storage box back into the host. Close the back cover of the main unit to complete the cleaning.

## Electrical schematic diagram

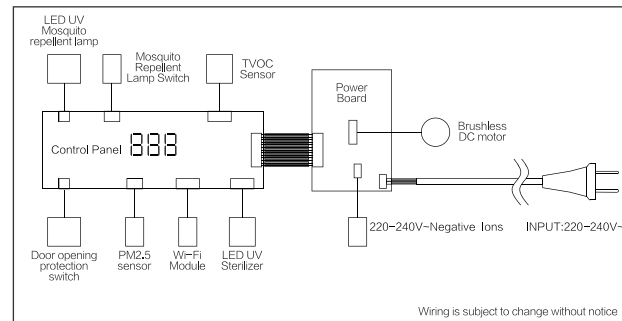

## Wi-Fi Connection

### Connect MIJIA APP

This product has been connected to Mijia, can be controlled through Mijia APP, and interconnected with other products.

Note: Due to the upgrade and update of the Mijia APP, the actual operation may be slightly different from the above description. Please follow the instructions in the current Mijia APP.

Please note that "works with mijia" only for software level verification, Xiaomi and Mijia do not take this product and the company's manufacturing, standards implementation, quality supervision, etc. Into responsible.



Scan the QR code to download and install the "Mijia" APP. Users who have installed the APP will directly enter the device connection page. Or search for or "Mijia" in the app store, download and install the APP. Open the APP homepage, click "+" in the upper right corner of the page, and add devices according to the APP prompt method.



## Phone Wi-Fi binding

Please make sure your phone is connected to Wi-Fi before connecting.  
Open the APP, click the "+" sign on the device interface to add the device.  
Select the connectable device and follow the prompts on the phone interface to complete the connection.  
Note: Please refer to "Wi-Fi Reset" when the mobile phone cannot be connected to the air purifier. Please connect to Wi-Fi for a better user experience.

## Wi-Fi Reset

After changing the router or Wi-Fi password, you need to reset the Wi-Fi. Please press and hold the "Wi-Fi" button for 3 seconds until the Wi-Fi icon on the display flashes, then reconnect to the Wi-Fi according to the method of binding Wi-Fi.

## Filter Replacement

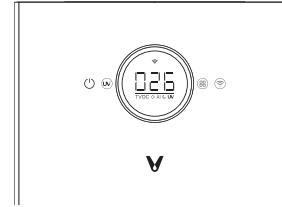

1. Shut down and power off the host

If the machine is started, short press the key to turn off the purifier. At this time, the purifier is in standby mode, you need to unplug the power supply to cut off the power to the host.

2. Open the filter cover  
Grasp the buckle of the filter cover and pull it out.

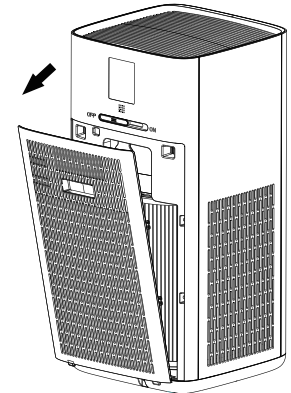

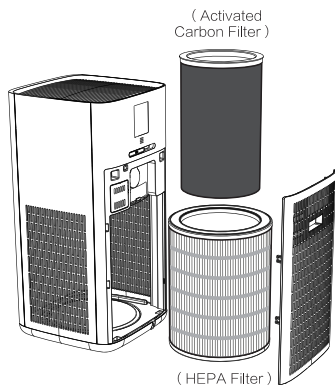

3. Take out the filter and wrap the waste filter material in a garbage bag to prevent the pollutants on the filter material from falling into the room.

Note:

- a. Please treat the waste filter as non-combustible garbage.
- b. It is recommended that the replacement cycle of the filter is about 8 to 12 months (the cycle of replacing the filter varies greatly due to different use environments)
- c. When the system displays "EE", it prompts to replace the filter.

4. Adjust the direction of the new filter to correspond to the purification. Install the filter slot on the filter, and then hold the filter cover, align the bottom of the filter cover with the groove on the bottom of the host, then close the door cover, plug in the power supply and run.

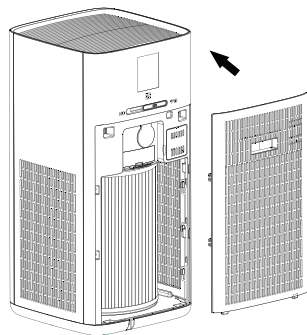

5. Please pay attention to the bottom of the filter installation. Please reset the filter reminder after the filter is replaced.

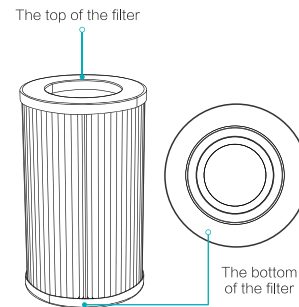

Note:

- a. Please read the filter replacement operation in detail to ensure the purification effect of the purifier.
- b. Before cleaning the purifier system, unplug the power supply and cut off the power to the purifier system.
- c. Keep the inside of the purifier dry to prevent damage to the circuit.
- d. When the surface area is dust, use a vacuum cleaner to clean the surface dust, which can prolong the service life of the filter.



## Safety Precautions

1. This appliance can be used by children aged from 8 years and above and persons with reduced physical, sensory or mental capabilities or lack of experience and knowledge if they have been given supervision or instruction concerning use of the appliance in a safe way and understand the hazards involved.
2. Children shall not play with the appliance.
3. Cleaning and user maintenance shall not be made by children without supervision.

### Power Supply Precautions

1. Only use two-pin sockets that meet the standard voltage on the nameplate;
2. If the power cord, power cord plug and power socket are damaged, please do not use the product;
3. When unplugging the power plug, you must hold the plug firmly and not pull the power cord. Otherwise it may cause electric shock or fire due to short circuit;
4. Regularly remove the dust from the power plug;
5. If the power cord is damaged, it must be replaced by the manufacturer or professional maintenance personnel.

### Moving

1. When moving, please stop running and pull out the power plug;
2. When moving, hold the handle on the side of the main unit; do not hold the front panel to prevent the main unit from falling and injuring people.

### In Use

1. Do not use the machine without a filter;
2. Do not insert your fingers or foreign objects into the air inlet or air outlet;
3. Do not block the air inlet / outlet;
4. Do not approach or place on heat source objects (such as heaters and other places that may contact with flammable gases)
5. If there are smoke, odor and other faults, you should immediately unplug the power plug.

### Using Limitation

1. Do not use when there is oil residue in the room, smoke when burning incense, flames when lighting, or chemical smell in the air;
2. Do not use the machine in an environment full of hydrogen, natural gas, propane and other flammable gases to avoid electric shock, fire and other damage;
3. Do not use this machine when using spray sandworm agent;
4. Do not use in unstable places such as dumping; bathroom and other places with high temperature, humidity and water; to avoid electric shock, fire or other damage.

### Warm Tips

1. There should be a certain space around the air purifier to allow the wind to flow naturally, thereby improving the purification effect;
2. This machine is not suitable for the disabled, handicapped, mentally handicapped or children.

## Common Troubleshooting Methods

### Troubleshooting List

Malfunction Phenomenon	Reason Analysis	Disposal Method
The machine doesn't start	The power plug is not installed	Reinsert the power plug
	Host filter cover is not installed in place	Reinstall the host filter cover and install it in place
The dust removal and purification effect is not significant and the air quality is not significantly improved	The machine is not equipped with a filter	Equip with a filter
	The machine is placed in a small place or there are obstacles nearby, affecting the purification effect	Clear the blockage or change place
	The filter is too dirty	Clean or replace the filter
Odor at the air outlet	There are many sources of pollution in the room	Reinstall the host filter cover and install it in place
	The filter is heavily polluted	Replace new filter
Too much noise	Whether the installation is not strong enough	Contact the after-sales service center
	There is debris in the machine	Remove debris
The filter won't fit in	The filter is reversed	Adjust the correct orientation of the filter and align it with the bottom slot

### Clean Attention

1. Do not clean the composite filter;
2. Please be careful when cleaning the machine, the strong corrosive cleaner will damage the surface of the machine;
3. Only use a soft cloth to clean the surface of the machine, otherwise the machine may be damaged or broken, and may also cause sensor failure;
4. It is forbidden to wipe with alcohol or organic solvents, otherwise it will damage the product or cause electric shock, fire, etc. ;
5. When cleaning the machine or not using the machine, please unplug the power plug from the power socket. It may cause electric shock or fire due to short circuit.

### Installation

1. When the filter cover is not installed correctly, the host cannot start;
2. Do not install it where the sensor directly faces the air outlet, otherwise it may affect the normal operation of the machine;
3. Do not install near objects that may contact the air inlet or outlet (such as curtains, etc.), otherwise the object may be contaminated or cause the machine to malfunction;
4. Do not install in a place where the machine may be directly exposed to condensation. Please use it at room temperature from 0 to 40 °C;
5. Do not install it in a place where black smoke will be generated (such as kitchen, etc.), otherwise it may cause the surface of the machine to crack or the sensor to malfunction.

## Troubleshooting List

Malfunction Phenomenon	Reason Analysis	Disposal Method
E0	The door cover is opened	1. Fasten the door cover 2. Contact the after-sales service center
E1	The machine is tipped or tilted	Make the machine stand upright
E2	The motor doesn't work	Reconnect the power supply, if you can't solve it, please contact the after-sales service center
EE	Filter life expires	Replace the filter element and reset. Reset operation: In the standby state, press button “  <p>*If the fault cannot be eliminated after the above inspection, please contact the after-sales service by phone: 400-100-2632. Do not disassemble and repair by yourself to avoid danger and damage to the machine.</p>

Body barcode:



Manufactured by: Foshan VIOMI Electrical Technology Co., Ltd. (a Mi Ecosystem company)

Address: 4F, Building 7 & 2F, Building 1, No. 2 North of Xinxi Fourth Street, Xiashi Village Committee of Lunjiao Sub-district Office, Shunde District, Foshan City, Guangdong Province, China