

# VIOMI

## Handheld wireless vacuum cleaner A9

Please read this manual carefully before use and keep it properly.  
The adapter supplied with this product can only be used at an altitude below 2000m.

CE ✓RoHS





## CONTENTS

Product Introduction	1
Installation Instructions	2
Product Operation	3
Maintenance	4
Troubleshooting	5
Precautions	6

Please read this instruction manual carefully to ensure correct and safe use of this product.

# Product Introduction

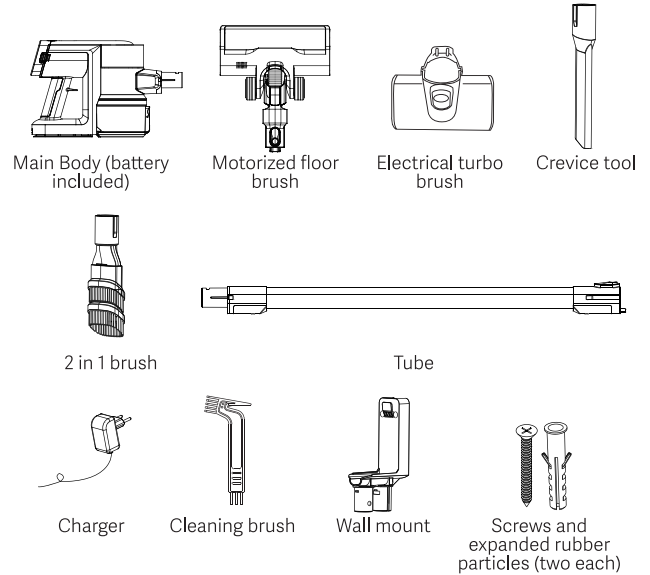
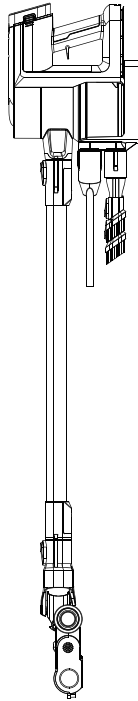

## Specifications:

Model: V-HWVC12 A	Dust cup volume: 0.4L
Battery capacity: 2500mAh lithium	Rate voltage: 25.2V
Power adapter input: 100-240V 50/60Hz	Rated power: 400W
Power adapter output: 30V 800mA	Charging time: 3.5 hours

## Installation Instructions

### Battery pack

Press the release buttons of the battery pack and slide it into the top of the hand vacuum. The battery will click into position when correctly installed.

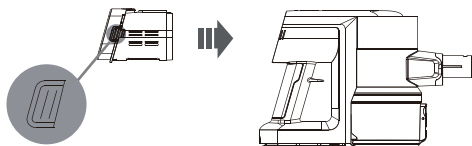

### Tube

Slide the tube into hand vacuum until it clicks into place. Press the release button to remove the tube.

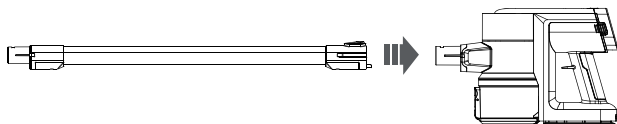

### Motorized floor brush

Slide the motorized brush into the tube until it clicks into place. Press the release button to remove the tube.

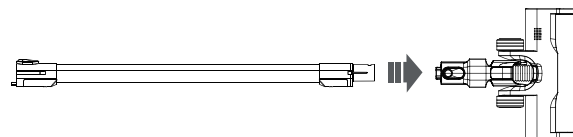

### Accessories

Push the crevice tool / 2 in 1 brush to suction tube or hand vacuum until it clicks into place.

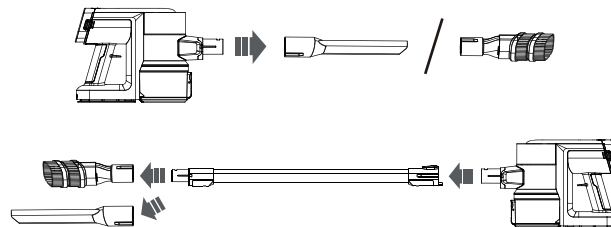

#### Note:

The crevice tool is suitable for cleaning narrow, slit or irregular object surface, such as corner, window slit, drawer, frame, keyboard, etc.

## Product Operation

### Start using

Please ensure vacuum cleaner has battery power before using.

Please charge the device for 3.5 hours at first use.

Press the  ON/OFF button to switch on the power, press again to stop the vacuum cleaner.

The speed adjustment button is the  on the top of the battery pack. The initial gear is set to the low gear. Each subsequent press switches between low gear, mid gear and high gear.

### Charging

The charging port is on the battery pack. Plug the charger into the power outlet to charge the machine. The battery pack can also be removed to charge separately.

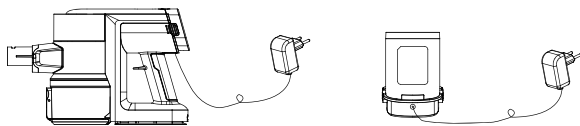

Note:

Please only use the original battery and charger. Do not use other replacement battery or charger.

Prevent the battery and charger from any shock or damage.

Keep the battery and charger away from water and any wet environments.

Put the battery pack at dry and cool place when charging.

Do not put the battery and charger in hot environment over 50 degree. Prevent them from direct exposure to sunshine. Keep them away from heated surface and cigarettes.

Do not repair by yourself when the battery or charger is defective. Please contact the customer service team for help.

### Indicator lights

This vacuum cleaner has 5 indicator lights and will be on after switching on.

The indicator lights show the current battery power.

When the battery is lower than 3%, the machine will be turned off automatically. And please charge the vacuum cleaner when it has 5 flashing indicator lights.

During charging, the 5 lights will keep flashing. After fully charged, there will be 5 solid lights. 5 minutes later, all lights will turn off and the unit will go into sleep mode.

### Storage

Install the wall-mounted tool on the wall with the screws in the package. Put the vacuum cleaner by inserting it into hook. The crevice tool and 2 in 1 brush can be stored on the wall mount as below picture.

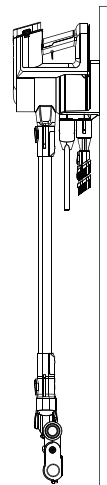

## Maintenance

### Clean the dust cup

Turn off the vacuum cleaner, press the release button to empty the dust cup.

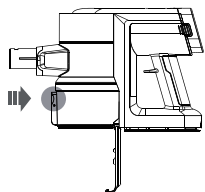

### Clean the filters

Empty the dust cup first, then pull out the filters. Both the metal filter and sponge filter can be cleaned. The bottom part of the dust cup can be removed. You can clean it thoroughly with the cleaning brush in the package.

Note: Reinstall the filters when they are completely dry.

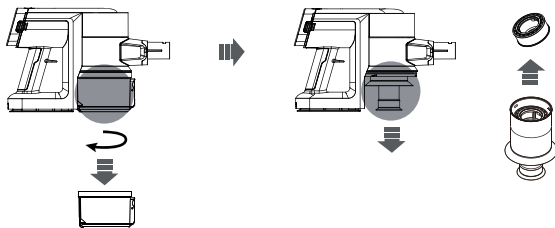

### HEPA filter removal

After shutdown, press the release button on the end of the HEPA filter element to remove the HEPA filter element for cleaning or replacement. Reverse the operation to restore the installation.

Tip: After cleaning the HEPA filter element, you need to dry it thoroughly before using it.

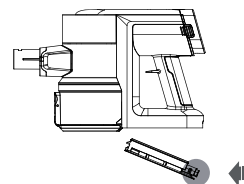

### Clean the floor brush

Turn off the vacuum cleaner, use a coin or other tool to unlock the roller brush lock. Then remove the roller brush for cleaning.

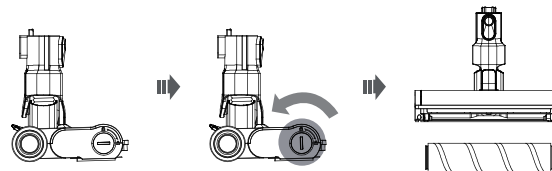

## Troubleshooting

Malfunction	Possible cause	Resolvent
The vacuum cleaner doesn't work	<ol style="list-style-type: none"> <li>1.lack of power</li> <li>2. suction mouth is blocked</li> </ol>	<ol style="list-style-type: none"> <li>1. charge the battery</li> <li>2. clean up the suction mouth</li> </ol>
Weak suction power	<ol style="list-style-type: none"> <li>1. Dust cup/filter is full of dust</li> <li>2. hairs or fibers are wrapped around the brush</li> </ol>	<ol style="list-style-type: none"> <li>1. clean up the dust cup and filters</li> <li>2. clean up the brush and accessories</li> </ol>
The motor is running with abnormal sound	The suction mouth or the tube is blocked	Remove the blockage
The roller brush doesn't rotate & LED lights don't work	<ol style="list-style-type: none"> <li>1. hair wrapped around the brush</li> <li>2. one or more sections may not be installed correctly</li> </ol>	<ol style="list-style-type: none"> <li>1. remove the blockage</li> <li>2. check every section and ensure a good connection</li> </ol>
The battery indicator lights keep flashing quickly	<ol style="list-style-type: none"> <li>1. the brush or the dust cup is blocked and the current is increased</li> <li>2. The environment is too high/low</li> <li>3. use wrong adapter to charge</li> </ol>	<ol style="list-style-type: none"> <li>1. remove the blockage</li> <li>2. charge the battery under a comfortable indoor temperature(0-50degree)</li> <li>3. Only use the original charger provided by Womow</li> </ol>



## Precautions

READ ALL INSTRUCTIONS BEFORE USING (THIS APPLIANCE), Failure to follow the warnings and instructions may result in electric shock, fire and/or serious injury. This appliance is designed for domestic use only.

1. This appliance can be used by children aged from 8 years and above and persons with reduced physical, sensory or mental capabilities or lack of experience and knowledge if they have been given supervision or instruction concerning use of the appliance in a safe way and understand the hazards involved. Children shall not play with the appliance. Cleaning and user maintenance shall not be made by children without supervision
2. This appliance is designed for domestic use only.
3. Do not pull on the connection cord, but rather on the plug, to separate the appliance from the mains.
4. Do not use outdoor.
5. Do not leave the appliance unattended when it is switched on, as this may be a source of danger.
6. Stand the appliance on a table or flat surface.
7. If the supply cord is damaged, it must be replaced by the manufacturer, its service agent or similarly qualified persons in order to avoid a hazard.
8. Following objects are strictly banned, otherwise the vacuum cleaner will be damaged or fire calamity will be caused, which bring such accidents as human body injuries:
  - Don't pick up large or sharp broken such as glasses,
  - Don't pick up harming or erodent liquids (solvent, corrosive, detergent...),
  - Don't pick up inflammable or explosive substance such as gasoline or alcohol.
9. Check the device and connections regularly for visible damage. The device must not be used if the housing is damaged or other damage is present.
10. Never attempt to open the device or the mains adapter yourself or to replace the connecting cable. Always have repairs to the device carried out by a specialist workshop. There is considerable danger to the user if repairs are faulty.
11. Do not trap the mains adapter cable and when using the adapter, pay attention to where the cable is to prevent any danger of tripping over it. Keep the cable away from heated surfaces (e.g. cooker surfaces).

12. Do not touch the mains adapter and cable with wet hands.
13. Do not point the vacuum cleaner at persons or animals when in operation.
14. Only use the mains adapter on dry surfaces in buildings.
15. Only use the device with the accessories supplied.
16. Please keep these instructions in a safe place.
17. Use only with the provided adaptor.
18. The appliance must only be supplied at safety extra low voltage corresponding to the marking on the appliance.
19. This appliance includes Li-ion batteries; do not incinerate the batteries or expose to high temperatures, as they may explode.
20. This appliance is only charged with the adaptor delivered together.
21. Do not use the vacuum cleaner when charging.
22. To avoid clogging of HEPA filter elements, it is recommended to use a cleaning brush to clean the filter elements regularly; it is recommended to replace the filter elements every 3-6 months.



Body barcode:



Manufactured by: Foshan VIOMI Electrical Technology Co., Ltd. (a Mi Ecosystem company)

Address: 4F, Building 7 & 2F, Building 1, No. 2 North of Xinxi Fourth Street, Xiashi Village Committee of Lunjiao Sub-district Office, Shunde District, Foshan City, Guangdong Province, China